

THE COMPORTEMENT OF THE METALIC POWDERS (Ti and LaserForm) IN SLS PROCESS

Baila D, baila.irina@email.ro

University of Cluj-Napoca, Machine Building Faculty

Abstract: The Ti powder (Ti-6%Al-4%V) is used like biomaterial in medicine to obtain the orthopaedic prothesis. The Ti powder have a good resistance to corrosion, is not toxic and can be more easy adopted like prothesis by human body. Other biomaterials used in medicine are the Ti powder (Ti-6Al-4V) and the hydroxiapatite powder. The powders used in SLS are conditioned for the process and for the final properties of prothesis.

1. INTRODUCTION

The orthopaedic prothesis are frequently made from the Ti powder (alloy Ti-6Al-4V) or hydroxiapatite.

The Ti powders can be obtained with the hydride-milling-dehydride process. The Ti powder is not toxic for human body and has goods mechanical properties and a good corrosion resistance. But like all materials, the implant aged and the resistance of fatigue is not very good and is necessary to change it. It is more easy adopted like prothesis by human body.

The selective laser sintering station use the Ti powders to obtain the prothesis in orthopedy, the hip prothesis, the knee prothesis, the shoulder prothesis.

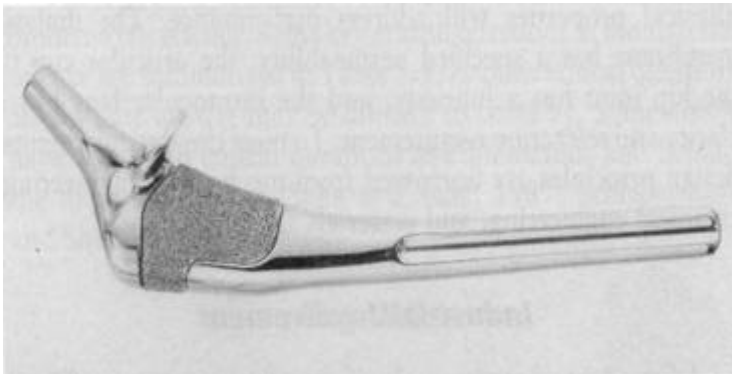

Fig.1. The hip prothesis



Fig.2. The knee prothesis

2. THE CHARACTERISTICS OF TI POWDERS USED IN SLS

The Ti powder used are realised with hydride-milling-dehydride process and have the morphology like in the fig.3. We obtain a powder with particles fines with irregular forms and with the marks vertex. This is a condition to manufacturing on SLS.

The powder must to be coat with a thermoplastic polymer. In time of process of SLS the thermoplastic polymer of two particles in contact must weld, for complete the resistance bridges of weld metal-metal.

The Ti powder are conditioned with PA (polyamide) or with PMMA (Polymethyl metacrilate).

We are interesting to know the adhesion of the thermoplastic polymer to Ti powder. For this we use a shearing machine (fig.4) and the proves of Ti are cover with PA, respective with PMMA. The PA6 have a good traction and a good resistance shearing and are a very good adhesion.

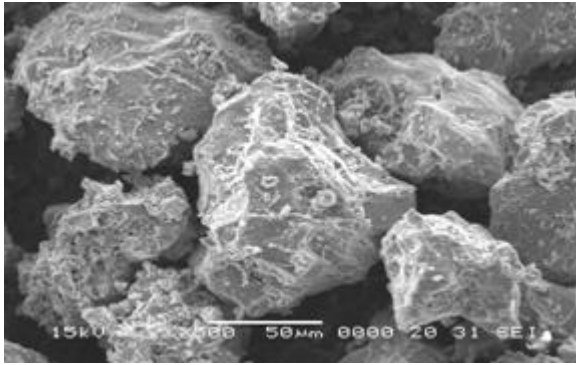

Fig.3. Morphology of Ti powder used in SLS

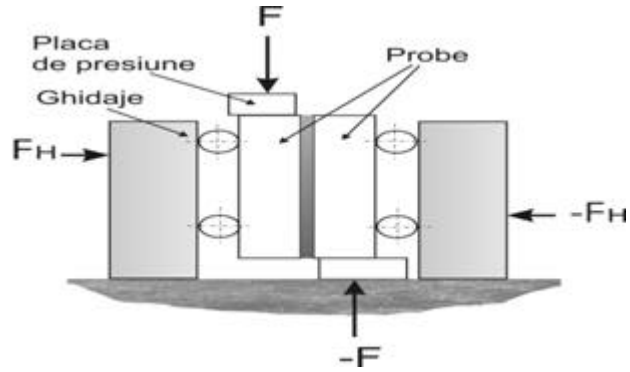

Fig.4. The shearing machine

The composite powder obtains (fig. by mixed of Ti powder with PA6 and acetone (fig.5) has goods properties to traction and to shearing resistance and we try to make 9 prisms on SLS.

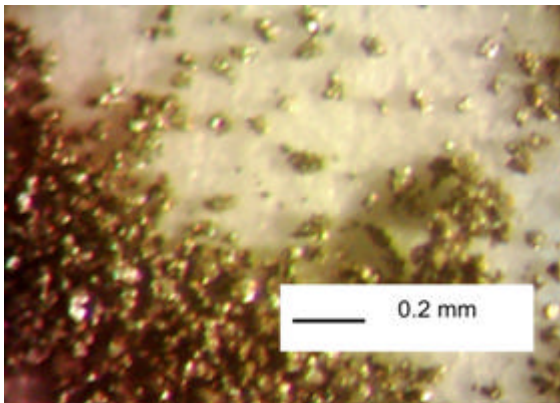

Fig.5. Composite powder Ti-PA6 (obtain with mixed with acetone)

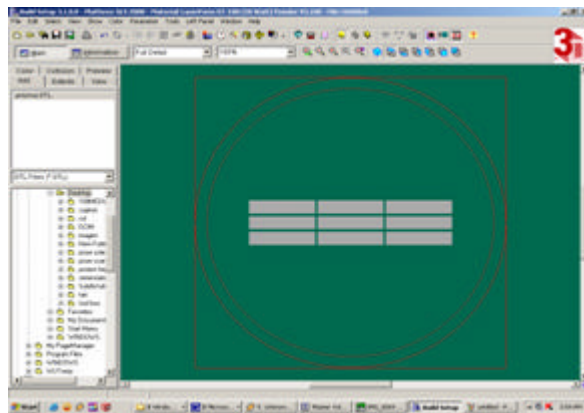

Fig.6. The prisms packet prepared for SLS

The prisms are realised to CAD (fig.6.) and we manufacture the prisms on sintering machine Sinterstation 2000.

We charge the bunkers of machine with titan powder and in exterior with bentonite for economy of Ti powder (fig.7.). The process of sintering is with flame to local level, because the bonding material melts.

We obtain the prisms, but are very rubbles and the support powder reinforces, because of diffusion of the warm in enceinte of machine. The delimitation of prisms is very difficult and after a time the prisms become rubbles.(fig.12)

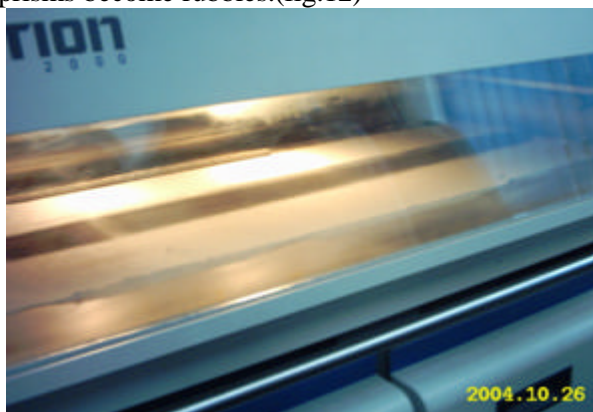

Fig.7. Manufacturing of the prisms of Ti powder on SLS

30 W	29 W	28 W
27 W	26 W	25 W
24 W	23 W	22 W

Fig.8. The laser powers applied on prisms



Fig.9. The manufacturing process with flame

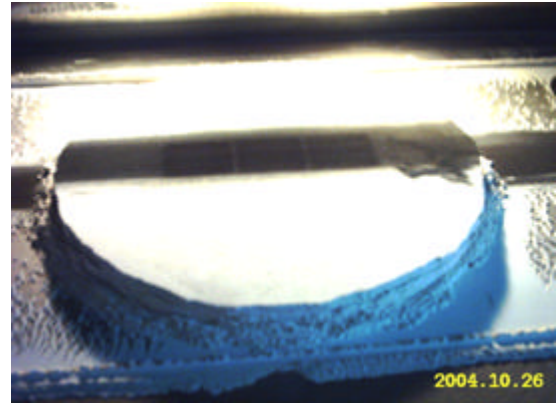

Fig.10. The prisms obtained on the SLS table



Fig.11. Cleaning the prisms



Fig.12. The prisms obtained with SLS method

We try too, to realise a Ti powder conditioned with PA, mixed with NaOH solution and then neutralise with HCl. We obtain a good powder with fines particles (fig.13)

We realise a conditioned Ti powder with PMMA (fig.14) and because PMMA have low temperature of polymerisation and is not exist the danger to impure the powder.

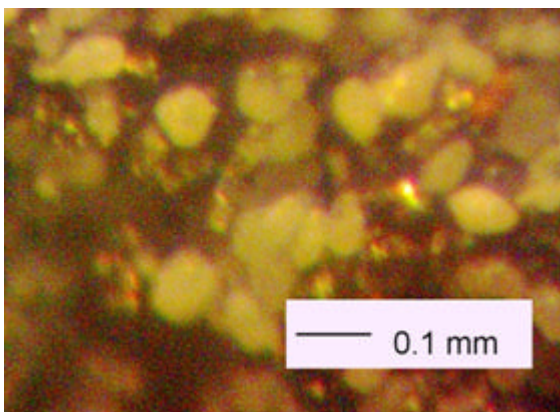

Fig.13. Composite powder Ti-PA6 (obtain with reaction of NaOH and neutralize in HCl)

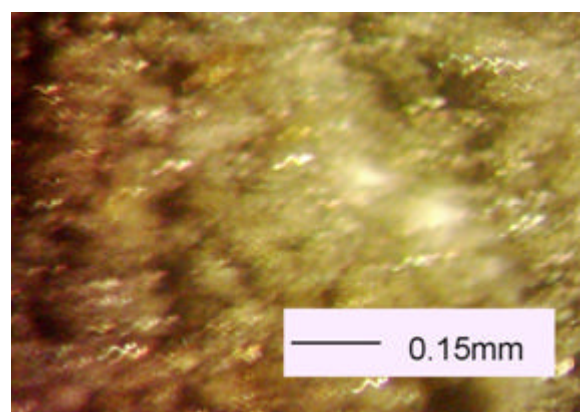

Fig.14. Composite powder Ti-PMMA

3. CONCLUSIONS

The Ti powder is a biomaterial who is used in medicine to implants. The implants are realised with SLS method and for this, the powders must to be coat (conditioned) with a thermoplastic polymer. In time of process of sintering the polymer melt and make the contact between particles and then are formed the bridges of weld metal-metal.

The presintering compacts realise by SLS must have a good mechanical stability to pass to final sintering. The thickness of the bridges metal-metal must assure a good mechanical stability in the phase of elimination of the bonding material.

A lower sintering of the particles of Ti powder can compromise the final form of the compact, if the bridges of weld metal-metal surrender before to realise the necks metal-metal. The adhesion metal-polymer coat must be good to assure the mechanical resistance of the precompact.

The Ti powder are very goods performances in medicine and is used to realises the orthopaedic protheses (shoulder, knee, hip), for stomatological implants and for medicine instruments.

4. BIBLIOGRAPHY

1-Biomaterials Science – An introduction to materials in medicine - Buddy D. Ratner si altii, Academic Press, 1996

2-Powder Metallurgy – Processing and materials – Werner Schatt, Klaus-Peter Wieters, EPMA, 1997